

SP Series

Close-coupled self-priming peripheral pumps with side channel and star impeller. Designed to remain primed even in the presence of waterdissolved gases or when the suction line is not filled with liquid.

The nickel-plated brass impeller prevents jamming due to oxidation.

Specifications

Delivery: up to 2.75 m³/h

Head: up to 50 m

Power supply: three-phase and single-phase 50 and 60 Hz

Power: 0.55 kW to 0.75 kW

Maximum operating pressure: 8 bar

Temperature of pumped liquid:
-10°C to +40°C

Maximum ambient temperature: 40°C

Insulation class: F

Protection: IP55

Materials

Pump body: Cast iron

Motor/pump support: Cast iron

Impeller: Nickel-plated brass

Front flange: Brass

Rear diffuser plate: Brass

Mechanical seal: Ceramic/Carbon/NBR

Fill plug: Brass

Elastomers: NBR

Applications

Water distribution

Washing

Pressure boosting

Irrigation



For a complete list of technical information, consult www.lowara.com

SP SERIES

Operating characteristics at 50 Hz

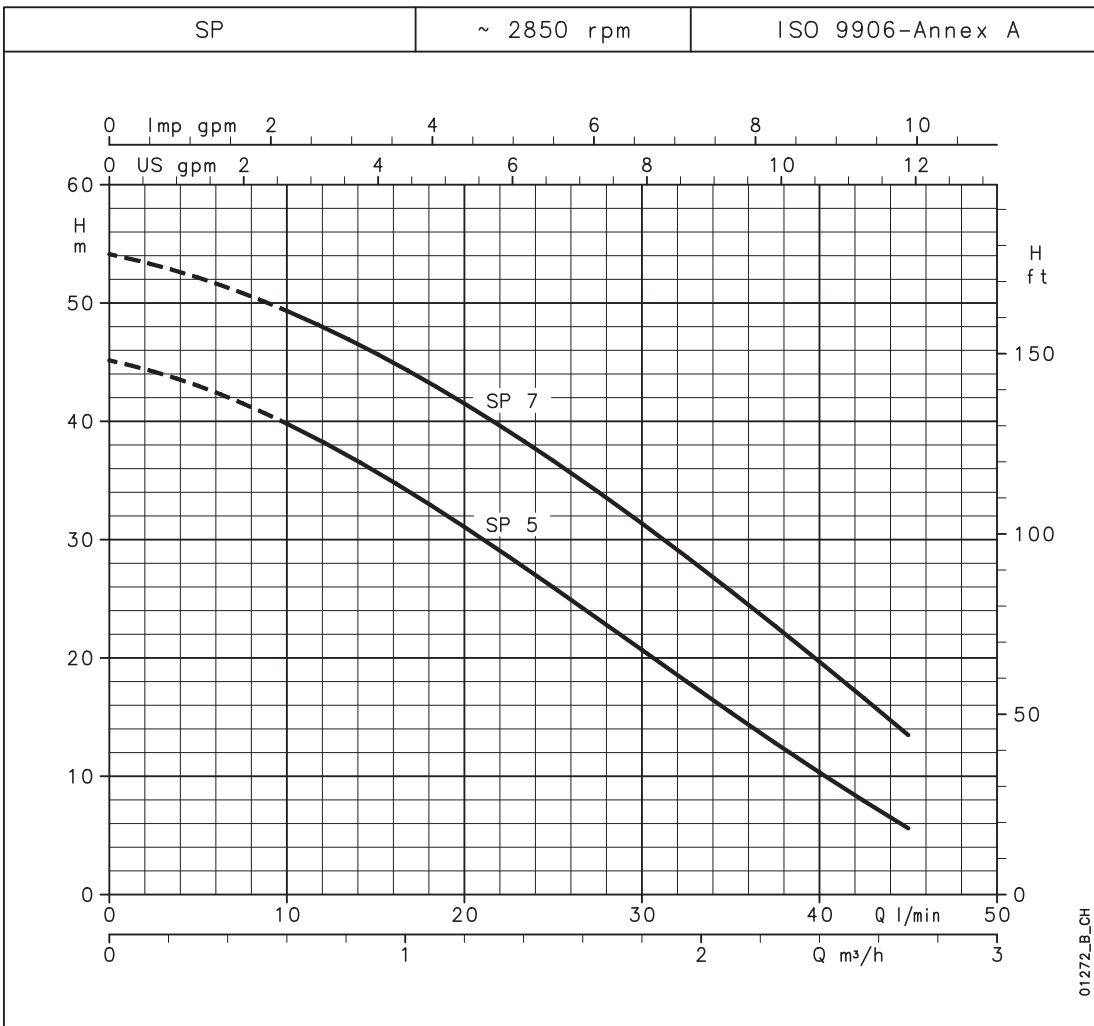

Hydraulic performance table

PUMP TYPE	RATED POWER		Q = DELIVERY								
			l/min	0	10	20	25	30	35	40	45
			m³/h	0	0,6	1,2	1,5	1,8	2,1	2,4	2,7
H = TOTAL HEAD IN COLUMN OF WATER (METRES)											
SP5(T)	0,55	0,75	45,2	39,8	31,1	26,0	20,7	15,4	10,3	5,7	
SP7(T)	0,75	1	54,1	49,3	41,5	36,7	31,4	25,7	19,7	13,5	

These performances are valid for liquids with density $\rho = 1.0 \text{ kg/dm}^3$ and kinematic viscosity $\nu = 1 \text{ mm}^2/\text{s}$.

sp-2p50_a_th

Electrical data

TYPE	TYPE	POWER*		CURRENT*		TYPE	TYPE	POWER*		CURRENT*	
		kW	A	220-240 V				kW	A	220-240 V	
1 ~						$\mu\text{F} / 450 \text{ V}$				3 ~	
SP5	SM71SP/1055	0,87	4,21	16	SP5T	SM71SP/305	0,78	2,67	1,54		
SP7	SM71SP/1075	1,00	4,60	20	SP7T	SM80SP/307HE	0,95	3,04	1,76		

*Maximum value in specified range

sp-2p50-en_b_te

1 SP SERIES Dimensions and weights

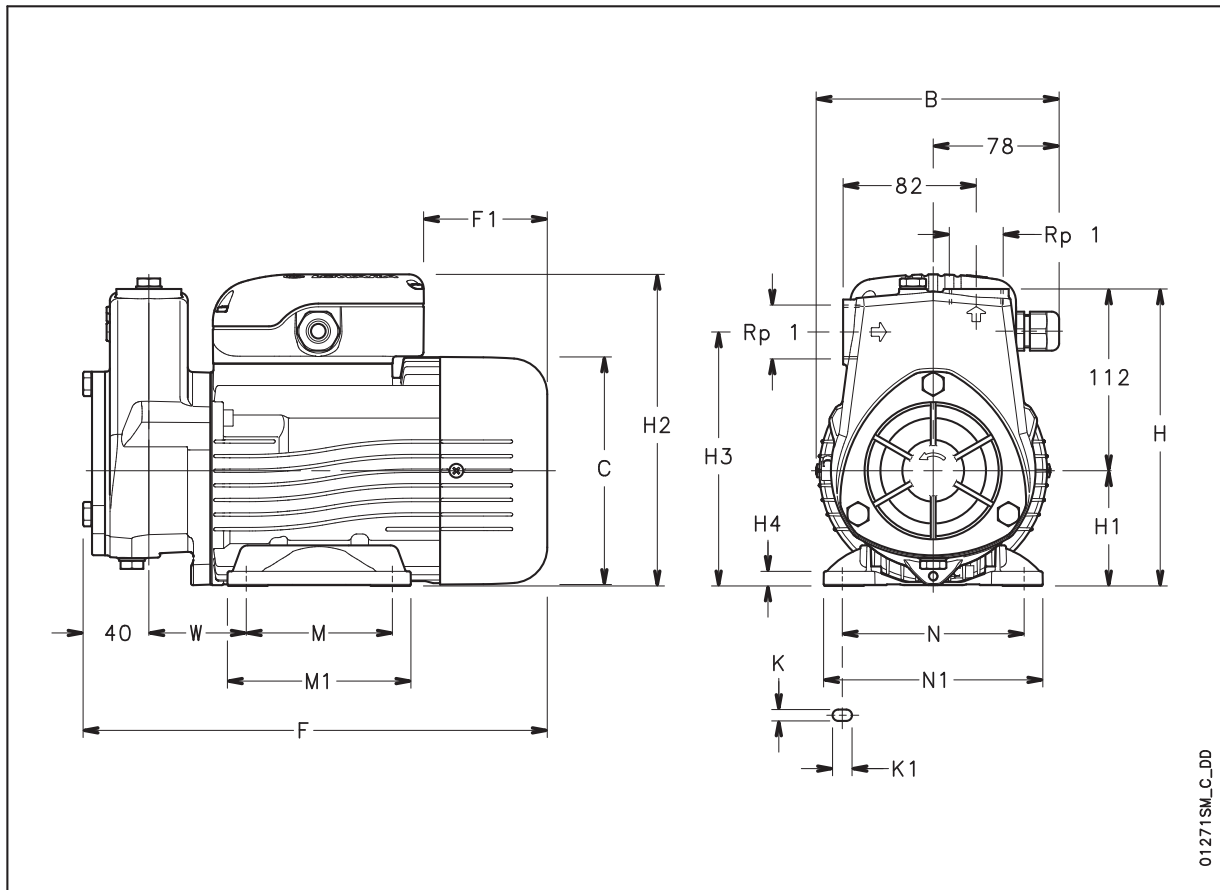

01271SM_C_DD

PUMP TYPE	DIMENSIONS (mm)															WEIGHT	
	B	C	F	F1	H	H1	H2	H3	H4	M	M1	N	N1	K	K1	W	kg
SP5	150	140	286	76	183	71	192	156	9	90	113	112	135	7	12	60	11
SP7	150	140	286	76	183	71	192	156	9	90	113	112	135	7	12	60	12
SP5T	150	140	286	76	183	71	192	156	9	90	113	112	135	7	12	60	11
SP7T	156	155	325	113	192	80	209	165	10	100	124	125	153	9	12	72	15

sp-2p50-en_b_td